

psm25
1993-2018 | YEARS

BENEFIT[®] .KFO

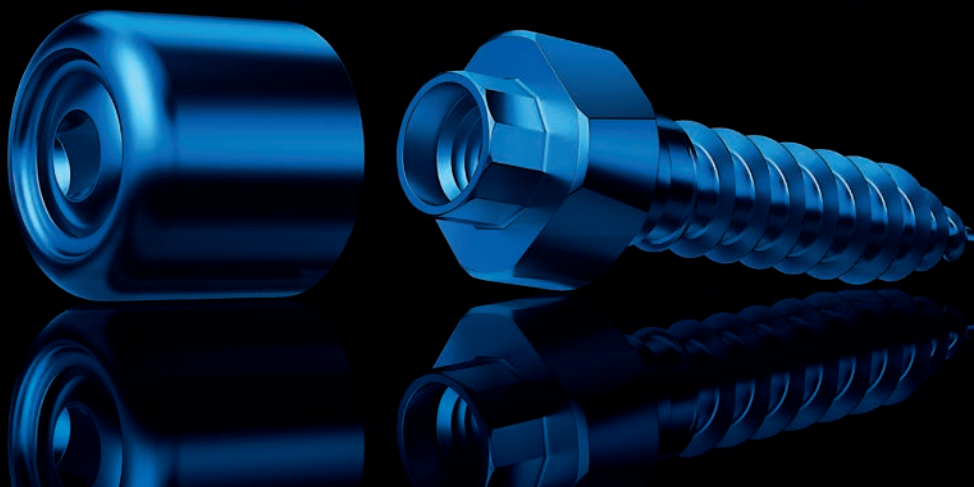

www.psm.ms – implants for professionals

made in Germany

TABLE OF CONTENTS
INHALTSVERZEICHNIS

	Page / Seite
Introduction Einführung	3
BENEslder BENEslder	4
Hybrid Hyrax, bmx Hybrid Hyrax, bmx	5
BENEFit Screws BENEFit Schrauben	6
Instruments Instrumente	7
Abutments Abutments	8
Temporary Pontics Temporary Abutments	9
Hybrid Hyrax RPE Hybrid Hyrax GNE	9
Distalization and Mesialization Distalisierung und Mesialisierung	10-11
BENEplate BENEplate	12-14
BENEplate single BENEplate einzeln	15
Optional Screwdrivers Optionale Schraubendreher	16
Drill Stop, MOPS Bohrerstop, MOPS	17
De Franco Parallel Guide De Franco Parallelführung	18
bmX BENEFit Maxillary Xpander bmX BENEFit Maxillary Xpander	18
Accessories Hilfsmittel	19
Scanbodies Scanbodies	19
Mobilholder Mobilholder	20
Screw Location Probe Zielsonde	21
BENEslder Titanium BENEslder Titan	22
Cordless Screwdriver Akku Schraubendreher	23
Ball Abutments Kugelabutments	24
Trays Behälter	25
BENEFit Instrument Sets BENEFit Instrumenten Sets	26-28
BENEslder Implant Sets BENEslder Implantat Sets	29-30

Developed in
cooperation with:
Entwickelt in
Zusammenarbeit mit:

Prof. Dr. Benedict
Wilmes
Kieferorthopädie
Heinrich Heine
Universität
Düsseldorf, GERMANY

benefit 2.0

benefit 2.3



Skeletal anchorage in orthodontics

An important requirement for successful orthodontic treatment is stable anchorage. Conventional orthodontic anchorage can be limited by periodontal disease and/or missing teeth. Skeletal anchorage has been proven to be very effective. It can be an essential part of non-compliance therapy and broadens the options available to the orthodontic practitioner.

Mini-Implants are especially advantageous because of the minimally invasive insertion protocol and their relatively low cost.

However, limitations can occur when conventional Mini-Implant systems are used for orthodontic anchorage.

In collaboration with leading specialists, PSM has developed the unique BENEFIT TAD System for temporary fixation in the palate. BENEFIT offers high precision titanium implant screws and a large variety of prefabricated connecting parts such as BENEplates, abutments and palatal expanders.

With the introduction of the BENEFIT System PSM has considerably enhanced the therapeutic diversity of the treatments available for Mesialization, Distalization, RPE as well as uprighting or anchorage of the dentition.

With BENEFIT, PSM was the first company to offer a full range of skeletal anchorage appliances for the palate – a trend that has become state-of-the-art in orthodontics.

Skelettale Verankerung in der Kieferorthopädie

Eine wichtige Voraussetzung für eine erfolgreiche kieferorthopädische Behandlung ist die hinreichend stabile und belastbare Verankerung. Die skelettale Verankerung hat sich hierfür in den letzten Jahren durchgesetzt und nicht zuletzt wegen ihrer Unabhängigkeit von der Patient compliance das Behandlungsspektrum der Kieferorthopädie enorm erweitert.

Unter den verschiedenen skelettalen Verankerungssystemen haben sich mittlerweile insbesondere die Mini-Implantate aufgrund ihrer geringen chirurgischen Invasivität und der relativ geringen Kosten etabliert.

Jedoch stößt man bei den herkömmlichen Mini-Implantat-Systemen bisweilen an Grenzen, wenn es um die Verbindung vom Mini-Implantat zur kieferorthopädischen Apparatur geht. PSM hat in Zusammenarbeit mit führenden Spezialisten das einzigartige BENEFIT Implantat System für die temporäre Verankerung im Gaumen entwickelt. BENEFIT bietet hochpräzise Implantatschrauben aus Titan und eine Vielzahl an vorkonfektionierten Verbindungsteilen wie BENEplates, Abutments und Gaumenexpander.

Mit der Einführung des BENEFIT Systems vor über 10 Jahren hat PSM die therapeutische Vielfalt mit Behandlungsoptimierungen u.a. bei der Mesialisierung, Distalisierung, GNE sowie der Verschiebung und Verankerung von sämtlichen Zähnen erheblich verbessert.

Mit dem BENEFIT System war PSM das erste Unternehmen, das ein rein knochengetragenes, palatinales Verankerungssystem angeboten hat, welches sich heutzutage als State-of-the-art in der Kieferorthopädie durchgesetzt hat.

INTRODUCTION EINFÜHRUNG

■ Note:

All products marked with **QB** can be used with **quattro**® and **BENEFIT**® screws!

■ Hinweis:

Alle mit **QB** gekennzeichneten Instrumente eignen sich zum Einsetzen von **quattro**® und **BENEFIT**® Schrauben!

BENESLIDER
BENESLIDER



BENESlider Video

The **BENESlider**

The most classical indication for skeletal anchorage using Mini-Implants with abutments is molar-distalization and/ mesialization in the maxilla. By means of the so called "**BENESlider**" the molars can be bodily distalized and/or mesialized using the Mesialslider. In many cases, tooth extraction or dental implants can be avoided.

To couple two **BENEFIT**® Mini-Implants, a **BENEplate** with welded wire is connected to the Implants and the **BENESlider** parts (mobilizer, springs, **BENETube**) are placed on the wire. Active force is applied by springs (240 g or 500 g) and activated with the Mobilizer.

Der **BENESlider**

Eine der klassischen Indikationen für eine skelettale Verankerung und insbesondere für Mini-Implantate mit Abutments stellt die Molarendistalisierung/-mesialisierung im Oberkiefer dar. Mittels des so genannten „**BENESlider**“ können die Molaren körperlich distalisiert werden. Mit Hilfe des Mesialsliders werden Zähne körperlich mesialisiert. So kann in vielen Fällen die Extraktion von bleibenden Zähnen und/oder dentale Implantate vermieden werden.

Zur Verbindung zweier **BENEFIT**® Mini-Implantate wird eine **BENEplate** mit Draht auf die Implantate geschraubt und die **BENESlider** Teile (Mobilisator, Federn, **BENETube**) auf den Draht aufgesteckt. Die ausführende Kraft wird über eine Feder (240 g oder 500 g) mittels Mobilisator aktiviert.



BENESlider Mesial/Distal

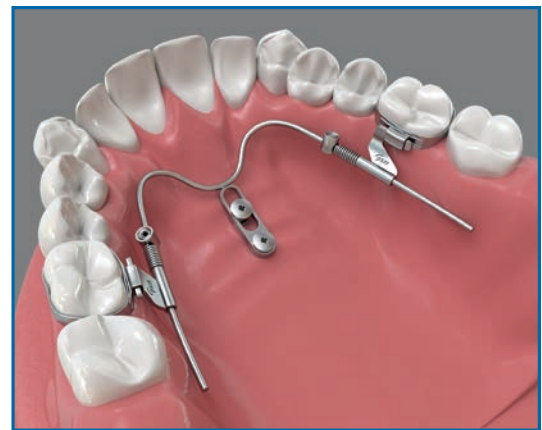

BENESlider Distal/Distal

Possible Indications: Mögliche Indikationen:

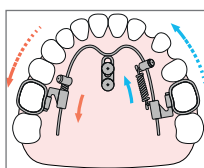

- Maxillary molar distalization and mesialization
Molarendistalisierung/-mesialisierung im Oberkiefer

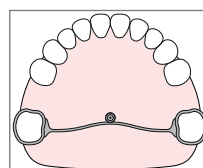

- Molar anchorage
Molarenverankerung
- Molar uprighting
Molarenaufrichtung

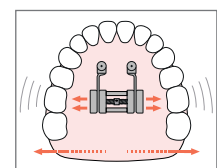

- Rapid palatal expansion RPE
Gaumennahterweiterung GNE

HYBRID HYRAX
HYBRID HYRAX



Hybrid Hyrax Video

The Hybrid Hyrax®

The new Hyrax® Ring and Hyrax® Abutment (page 9) facilitate the construction and fixation of a Hybrid Hyrax® appliance. It allows welding or soldering with the Hyrax® Screw as well as little rotation movements when connecting the appliance to the BENEFIT Screws. The Hyrax® Ring is supplied with 1 fixation screw each.

Der neue Hyrax® Ring und das Hyrax® Abutment (Seite 9) erleichtern das Herstellen und Anbringen der Hybrid Hyrax® Apparatur. Er ermöglicht das Anschweißen oder Anlöten der Hyrax® Schraube an den flachen Teil des Rings und erlaubt kleinste Rotationsbewegungen beim Verbinden der Apparatur mit der BENEFIT Schraube.



Hybrid Hyrax

The bmx – BENEFIT Maxillary Xpander

Additionally to the Hybrid Hyrax that is available for some years now the Orthodontists expressed their desire for an appliances that is exclusively anchored on mini-implants. The new bmx System now offers the possibility for an enforced, non-surgical RPE with adolescent patients up to 13 years based on 2 paramedian anchored **BENEFIT** miniscrews. The pre-fabricated **bmX** expanders with 6 mm, 8 mm and 10 mm distance can be installed in the palate without an impression or additional laboratory work using the De Franco Parallel Guide (page 18).



bmX BENEFIT Maxillary Xpander

Zusätzlich zu der schon seit einigen Jahren zum Einsatz kommenden Hybrid Hyrax entstand seitens der Kieferorthopäden der Wunsch Apparaturen zu verwenden, die ausschließlich miniimplantatverankert arbeiten.

Das neue **bmX** (**BENEFIT** Maxillary Xpander) System von PSM eröffnet nun die Möglichkeit, die forcierte, nicht-chirurgische Gaumennahterweiterung bei jungen Patienten bis 13 Jahren über 2 paramedian gesetzte **BENEFIT** Minischrauben zu verankern.

Die in den Abmessungen 6 mm, 8 mm und 10 mm vorkonfektionierten **bmX** Dehnschrauben können ohne vorherige Abformung und ohne zusätzliche Laborarbeiten mit Hilfe der De Franco Parallel Führungen (Seite 18) im Gaumen eingebracht werden.

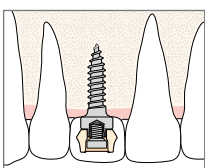

■ Temporary tooth replacement
Temporärer Zahnersatz

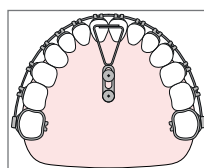

■ Anterior anchorage
Frontverankerung im Oberkiefer

... plus many more.
... und viele andere.

SCREWS

SCHRAUBEN

Material: Titanium

Material: Titan

Packaging: 1 ea.

VPE: 1Stk.

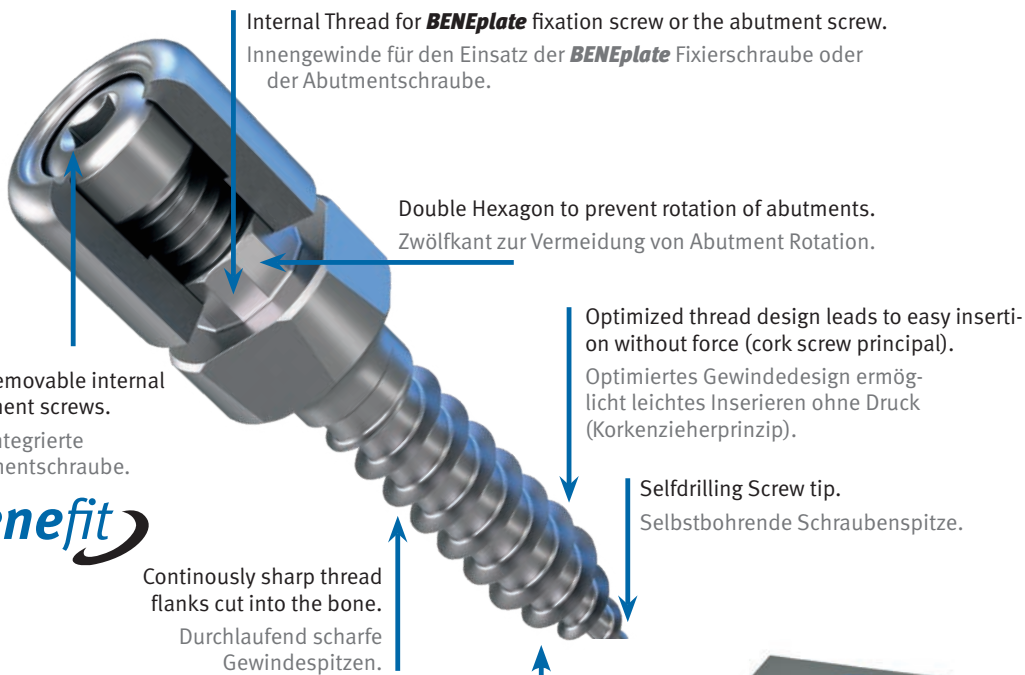

benefit



ST-33-54207-2	2.0 x 7 mm
ST-33-54209-2	2.0 x 9 mm
ST-33-54211-2	2.0 x 11 mm

BENEFIT® Screws in package of 2 ea.
BENEFIT® Schrauben mit VPE 2 Stk.



Direct screw removal from the sterile holder.
Entnahme der Schraube direkt aus der Sterilhalterung.



	Size (d x length) Abmessung (d x length)	ST ■
2.0	ST-33-54207 2.0 x 7 mm	 ST ■
	ST-33-54209 2.0 x 9 mm	
	ST-33-54211 2.0 x 11 mm	
	ST-33-54213 2.0 x 13 mm	
BENEFIT® Orthodontic Screw 2.0 mm, Material Titanium BENEFIT® KFO-Schraube 2,0 mm, Material Titan		

	QB ■ DENTAL
10-67513	 DENTAL
Drill, 1.4 x 33 mm WL 15 mm, red for 2.0 mm screws	
Bohrer, 1,4 x 33 mm AT 15 mm, rot für 2,0 mm Schrauben	



	Size (d x length) Abmessung (d x length)	ST ■
2.3	ST-33-54307 2.3 x 7 mm	 ST ■
	ST-33-54309 2.3 x 9 mm	
	ST-33-54311 2.3 x 11 mm	
	ST-33-54313 2.3 x 13 mm	
BENEFIT® Orthodontic Screw 2.3 mm, Material Titanium BENEFIT® KFO-Schraube 2,3 mm, Material Titan		

	QB ■ DENTAL
11-18452	 DENTAL
Drill, 1.8 x 33 mm WL 15 mm, grey for 2.3 mm screws	
Bohrer, 1,8 x 33 mm AT 15 mm, grau für 2,3 mm Schrauben	

ST ■

Note:

All implants are supplied in sterile single use packaging.

Hinweis:

Alle Implantate werden grundsätzlich in einer sterilen Einzelpackung geliefert.



33-54410

BENEFIT® impression cap, 1 ea.
BENEFIT® Abdruckkappen, 1 Stk.



33-54425

BENEFIT® laboratory analog, 1 ea.
BENEFIT® Labor/Manipulierimplantat, 1 Stk.

LABORATORY
LABOR

Impression Taking
Abdrucknahme



33-18236

QB

Thumb screw for Dental mandrel
Handgriff für Instrumente mit Dentalansatz



33-18232 23 mm

QB DENTAL

33-18233 28 mm

QB DENTAL

33-18237 33 mm

QB DENTAL

Screwholder for contra-angled handpiece
Schraubenhalter für Winkelhandstück

INSTRUMENTS
INSTRUMENTE

Packaging: 1 ea.
VPE: 1 Stk.



NOT SUITABLE FOR IMPLANTS,
ACCESSORIES ONLY.
Nicht geeignet für
Implantate! Nur Zubehör.

33-18266

QB

Thumb screw for Dental mandrel with
limited torque (10 Ncm)
Handgriff für Instrumente mit Dentalansatz
mit begrenztem Drehmoment (10 Ncm)



33-54512 20 mm

DENTAL

33-54515 30 mm

DENTAL

33-54518 50 mm

DENTAL

Screwdriver insert e.g. for abutment retaining screws, **BENEplate**
fixation screws and Mobilizer activation

Eindrehinstrument z.B. passend zu Abutment Schraube, **BENEplate**
Fixierschraube und Mobilisator Schraube



33-18244

QB DENTAL

Extension, +16 mm
Verlängerung, + 16 mm



The extension of 16 mm works for all rotary instruments of the **quattro**® and **BENEFIT**®-System with a latch type DENTAL attachment (max. rpm 600).

Die Verlängerung um 16 mm kann mit allen rotierenden Instrumenten der **quattro**®- und **BENEFIT**®-Systeme mit DENTAL Ansatz verwendet werden (max. 600 U/min.).

ABUTMENTS
ABUTMENTS

Material: Steel
Material: Stahl

Packaging: 1 ea.
VPE: 1Stk.



33-54430

BENEFIT® Abutment Standard
BENEFIT® Abutment Standard



33-54460 1.1 mm stainless steel

Abutment Standard with 1.1 mm wire (12 cm)
Abutment Standard mit 1,1 mm Draht (12 cm)



33-54450 Abutment with | mit 1 bracket

33-54452 Abutment with | mit 2 brackets

BENEFIT® Abutment with brackets
BENEFIT® Abutment mit Brackets



33-54445

Abutment with loop acc. to Dr. S. Renger,
St. Louis, France
Abutment mit Öse nach Dr. S. Renger,
St. Louis, Frankreich

Internal Thread for **BENEplate** fixation screw
or the abutment screw.

Innengewinde für den Einsatz der **BENEplate**
Fixierschraube oder der Abutmentschraube.

Double Hexagon to prevent
rotation of abutments.
Zwölfkant zur Vermeidung von
Abutment Rotation.

Non removable internal
abutment screws.
Fest integrierte
Abutmentschraube.

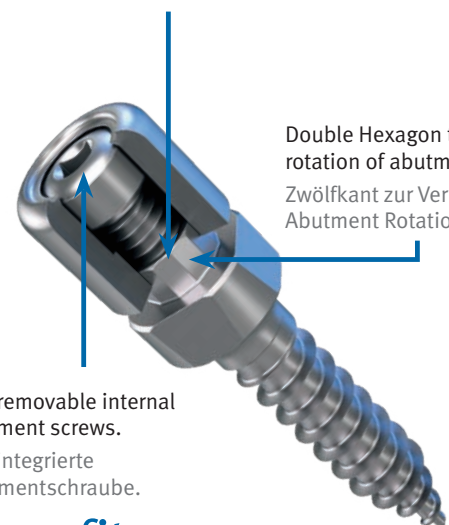

■ **Note:**

New Ball Abutment on
page 24.

■ **Hinweis:**

Neues Kugelabutment
siehe Seite 24.



33-54466

BENEFIT® Peek Abutment, incl. 1 fixation screw
BENEFIT® Peek Abutment, inkl. 1 Fixationsschraube



33-54469

BENEFIT® Peek Abutment, 15° angled incl. 1 fixation screw
BENEFIT® Peek Abutment, 15° abgewinkelt inkl. 1 Fixationsschraube

New
Neu

TEMPORARY PONTICS
TEMPORÄRER ZAHNERSATZ

Material: Peek
Material: Peek
Packaging: 1ea.
VPE: 1Stk.

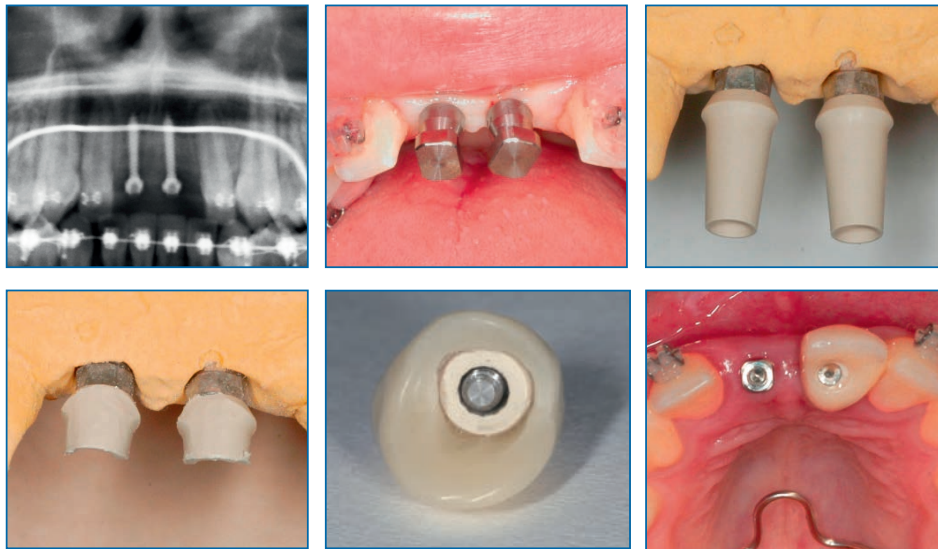

33-54462

Hyrax® Ring, incl. 1 fixation screw, 2 ea.
Hyrax® Ring, inkl. 1 Fixationsschraube, 2 Stk.

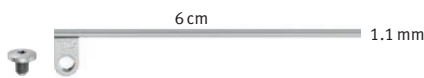

33-54465

Single Plate with 6 cm, 1.1 mm wire
Einzelplatte mit 6 cm, 1.1 mm Draht



33-54463

BENEFIT® Hyrax® Abutment, 1 ea
BENEFIT® Hyrax® Abutment, 1 Stk.

The new Hyrax® Ring and Hyrax® Abutment facilitate the construction and fixation of a Hybrid Hyrax® appliance. It allows welding or soldering with the Hyrax® Screw as well as little rotation movements when connecting the appliance to the BENEFIT Screws. The Hyrax® Ring is supplied with 1 fixation screw each.



Der neue Hyrax® Ring und das Hyrax® Abutment erleichtern das Herstellen und Anbringen der Hybrid Hyrax® Apparatur. Er ermöglicht das Anschweißen oder Anlöten der Hyrax® Schraube an den flachen Teil des Rings und erlaubt kleinste Rotationsbewegungen beim Verbinden der Apparatur mit der BENEFIT Schraube. Der Hyrax Ring wird mit einer Fixationsschraube geliefert.

HYBRID HYRAX RPE
HYBRID HYRAX GNE

■ **Note:**
Further Hyrax Ring versions see on page 15.
■ **Hinweis:**
Weitere Hyrax Ring Varianten siehe Seite 15.

**DISTALIZATION
DISTALISIERUNG**

Packaging: 2 ea.
VPE: 2 Stk.

DISTALIZATION



BENEsider Distal



33-54543

Micro Mobilizer
for wires from 0.5 to 1.2 mm
Micro Mobilisator
für 0,5 – 1,2 mm Draht



33-54540

Mobilizer
for wires from 0.5 to 1.2 mm
Mobilisator
für 0,5 – 1,2 mm Draht



33-54524 240 gr.

BENEsider NiTi springs
BENEsider NiTi Federn



33-54525 500 gr.

BENEsider NiTi springs
BENEsider NiTi Federn



33-54536

BENEsider, long
BENEsider, lang



33-54535

BENEsider for lingual brackets
BENEsider für Lingualtechnik



33-54549

FlexiTube, long
FlexiTube, lang



33-54550

FlexiTube, short
FlexiTube, kurz



33-54544

BENEsider acc. to Dr. Banach,
with wire 1.1 mm, 40 mm
BENEsider nach Dr. Banach,
mit Draht 1,1 mm, 40 mm

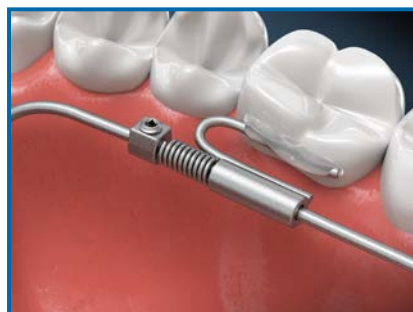

■ **Note:**

For complete Sets see
page 29/30.

■ **Hinweis:**

Die kompletten Sets
finden Sie auf Seite
29/30.



MESIALIZATION
MESIALISIERUNG

Packaging: 2 ea.
VPE: 2 Stk.

Mesialslider



33-54553

Micro Mobilizer
with hook
Micro Mobilisator
mit Haken



33-54541

Mobilizer
with hook
Mobilisator
mit Haken

6, 9, 12 mm



33-54495 140 gr. 6 mm, soft / leicht

33-54496 200 gr. 6 mm, medium / mittel

33-54497 250 gr. 6 mm, strong / stark

33-54695 140 gr. 9 mm, soft / leicht

33-54696 200 gr. 9 mm, medium / mittel

33-54697 250 gr. 9 mm, strong / stark

33-54795 140 gr. 12 mm, soft / leicht

33-54796 200 gr. 12 mm, medium / mittel

33-54797 250 gr. 12 mm, strong / stark

Mesialslider NiTi coil springs
Mesialslider NiTi Zugfedern



33-54539

Mesialtube with hook
Mesialtube mit Haken



33-54545

Mesialtube acc. to Dr. Banach with wire 1.1 mm, 40 mm and hook
Mesialtube nach Dr. Banach mit Draht 1.1mm, 40mm und Haken

MESIALIZATION

■ **Note:**

Complete Sets see page 29/30.

■ **Hinweis:**

Die kompletten Sets finden Sie auf Seite 29/30.

BENEplate

Packaging: 1 ea.
VPE: 1Stk.



BENEsider Video

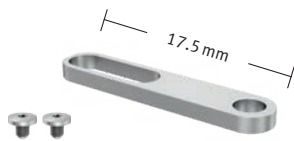

33-54400 stainless steel 1:1

BENEplate, long, incl. fixation screws
BENEplate, lang, inkl. Fixierschrauben

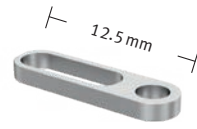

33-54402 stainless steel 1:1

BENEplate, short, incl. fixation screws
BENEplate, kurz, inkl. Fixierschrauben



1.1mm



33-54429 1.1 mm stainless steel 1:1

BENEplate, long, with 1.1 mm wire (12 cm)
BENEplate, lang, mit 1,1 mm Draht (12 cm)

33-54409 1.1 mm stainless steel 1:1

BENEplate, short, with 1.1 mm wire (12 cm)
BENEplate, kurz, mit 1,1 mm Draht (12 cm)



0.8mm



33-54428 0.8 mm stainless steel 1:1

BENEplate, long, with 0.8 mm wire (12 cm)
BENEplate, lang, mit 0,8 mm Draht (12 cm)

33-54408 0.8 mm stainless steel 1:1

BENEplate, short, with 0.8 mm steel wire (12 cm)
BENEplate, kurz, mit 0,8 mm Stahldraht (12 cm)

Note:

All **BENEplates** are supplied with 2 fixation screws

Hinweis:

Alle **BENEplates** werden ab Werk mit 2 Fixierschrauben geliefert



33-54407 1:1

BENEplate long, with bracket
BENEplate lang, mit Bracket



33-54420 0.8 mm TMA 1:1

BENEplate, short, with 0.8 mm TMA wire (12 cm)
BENEplate, kurz, mit 0,8 mm TMA-Draht (12 cm)

BENEplate



33-54472 1.1 mm stainless steel 1:1

BENEplate, long, with 1.1 mm lateral wire (12 cm)

BENEplate, lang, lateraler 1,1 mm Draht (12 cm)



BENEslider after Hybridhyrax
BENEslider nach Hybridhyrax



33-54471 1.1 mm stainless steel 1:1

BENEplate, short, incl. fixation screws, with 1.1 mm lateral wire (12 cm)

BENEplate, kurz, inkl. Fixierschrauben, lateraler 1,1 mm Draht (12 cm)



33-54475 0.8 + 1.1 mm stainless steel

Anka Plate, short, with 0.8 mm + 1.1 mm wire (12 cm)

Anka Plate, kurz, mit 0,8 mm + 1,1 mm Draht (12 cm)

acc./nach Dr. George Anka, Tamashi, Tokyo, Japan

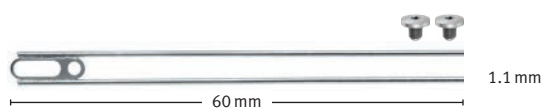

33-54477

BENEplate, short, with bi-lateral 1.1 mm wire 6 cm

BENEplate, kurz, mit 1.1 mm bilateralem Draht 6 cm

acc./nach Dr. Thomas Banach, Königsstein/Ts., Germany



■ **Note:**

All **BENEplates** are supplied with 2 fixation screws

■ **Hinweis:**

Alle **BENEplates** werden ab Werk mit 2 Fixierschrauben geliefert

BENEplate

Packaging: 1 ea.
VPE: 1Stk.

33-54480

BENEplate, long, with central 1.1 mm wire (12 cm)
BENEplate, lang, mit 1.1 mm mittigem Draht (12 cm)
acc./nach Dr. Nienkemper, Düsseldorf, Germany



33-54485

T-Mesialslider plate, long, with central 1.1 mm wire and 0.8 mm wire anteriorly (12 cm)
T-Mesialslider Platte, lang, mit 1.1 mm mittigem Draht und 0,8 mm Draht anterior (12 cm)

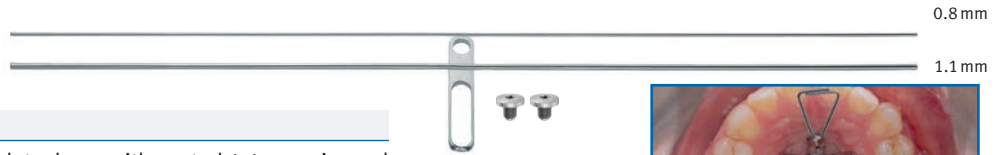

33-54490

T-Mesialslider plate, long, with central 1.1 mm wire (12 cm) and 2x 0.8 mm wire laterally (6 cm/ea.)
T-Mesialslider Platte, lang, mit 1.1 mm mittigem Draht (12 cm) und 2x 0,8 mm Draht lateral (je 6 cm)

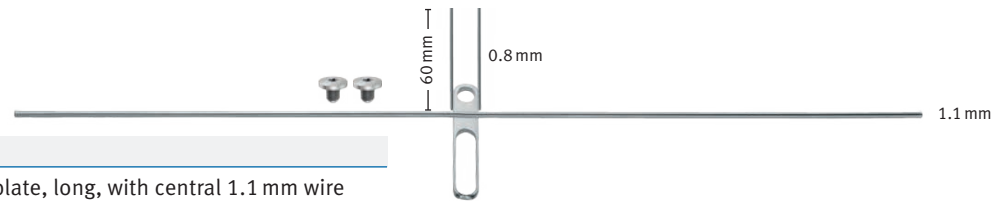

33-54492

T-Mesialslider plate, long, with 1.1 mm lateral wire (12 cm) and 0.8 mm wire vertically
T-Mesialslider Platte, lang, mit 1.1 mm Draht lateral (12 cm) und 0,8 mm Draht vertikal



33-54493

T-Mesialslider plate, short, with 1.1 mm lateral wire (12 cm) and 0.8 mm wire vertically
T-Mesialslider Platte, kurz, mit 1.1 mm Draht lateral (12 cm) und 0,8 mm Draht vertikal



Note:

All **BENEplates** are supplied with 2 fixation screws

Hinweis:

Alle **BENEplates** werden ab Werk mit 2 Fixierschrauben geliefert



33-54403

Spare fixation screws, 2 ea.
Ersatz Fixierschrauben, 2 Stk.



33-54703

Spare fixation screws long, 2 ea.
Ersatz Fixierschrauben lang, 2 Stk.

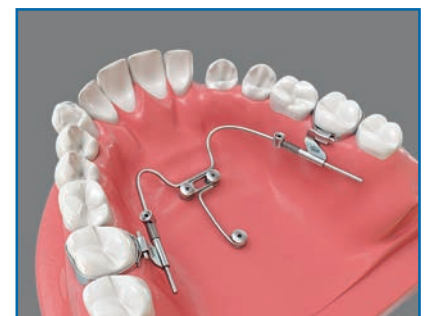

Tripod

NEW



BENEplate single
BENEplate einzeln

Material: Stainless Steel
Material: Rostfreier Stahl
Packaging: 1ea
VPE: 1 Stk.



News 22

33-54730

Arnoudizer for indirect anchorage acc. Dr. A. Schreurs, incl. fixation screw
Arnoudizer für die indirekte Verankerung nach Dr. A. Schreurs, inkl. Fixationsschraube

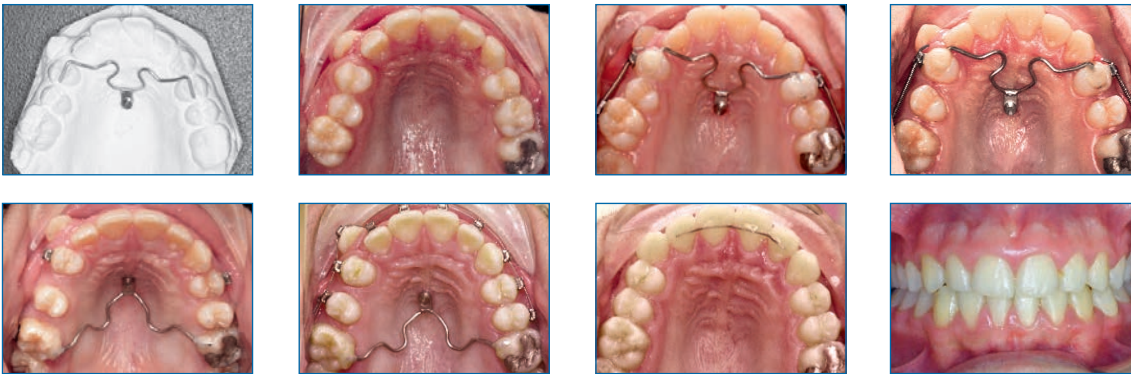

Developed in cooperation with:
Dr. Arnoud Schreurs, Orthodontist, Genk, Belgium
Entwickelt in Zusammenarbeit mit:
Dr. Arnoud Schreurs, Orthodontist, Genk, Belgium

A device for molar distalization. The upper molars will be derotated, uprighted and distalized in only two or three months. By converting the system in a transpalatal bar, it can be used as an anchor for the molars. The anterior teeth can be retracted and aligned simply.

Eine Vorrichtung zur Molarendistalisierung. Die oberen Molaren werden in nur zwei oder drei Monaten derotiert, aufgerichtet und distalisiert. Durch die Umwandlung des Systems in einen transpalatinalen Bogen, kann der Arnoudizer als Verankerung für die Molaren verwendet werden. Die Prämolaren können einfach distalisiert und ausgerichtet werden.

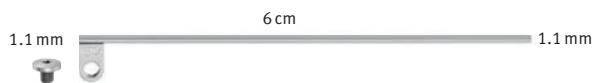

33-54465

Single Plate with 6 cm, 1.1 mm wire laterally, incl. 1 fixation screw
Einzelplatte mit 6 cm, 1.1 mm Draht seitlich, inkl. 1 Fixationsschraube



33-54461

Single Plate with 12 cm, 1.1 mm wire, incl. 1 fixation screw
Einzelplatte mit 12 cm, 1.1 mm Draht, inkl. 1 Fixationsschraube



33-54464

2 Single Plates with 12 cm, 1.1 mm wire, incl. 2 fixation screw
2 Einzelplatten mit 12 cm, 1.1 mm Draht, inkl. 2 Fixationsschraube

OPTIONAL SCREWDRIVERS
OPTIONALE
SCHRAUBENDREHER

Packaging: 1 ea.
VPE: 1 Stk.

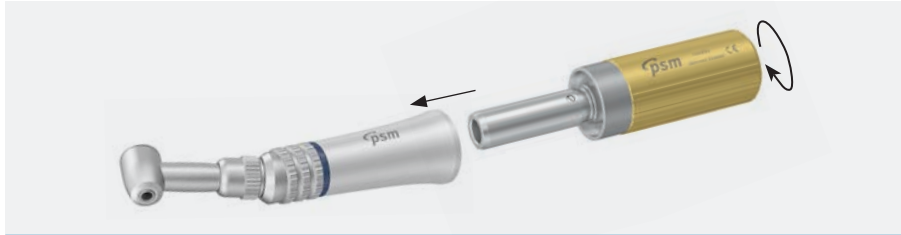

The manually turned unit is connected to your existing contra-angled handpiece (blue 1:1) that enables its use like an angled screwdriver.

Der manuelle Drehansatz wird einfach auf ein handelsübliches Winkelhandstück (blau 1:1) aufgesetzt, welches damit als Winkelschraubendreher verwendet werden kann.



10-63025

QB

Manually turned unit for contra-angled handpieces

Manueller Drehansatz für Winkelhandstücke



33-54704

QB

Manually turned unit mod. to Pauls, with adjustable torque from 0 – 40 Ncm

Manueller Drehansatz mod. nach Pauls, mit einstellbarem Drehmoment von 0 – 40 Ncm



33-18288

Laboratory Finger Screwdriver, fixed
Labor Finger Schraubendreher, fest



33-54520

Multi purpose handle for the use with instruments with dental shaft end.

Vielzweck-Handgriff für die Aufnahme von Instrumenten mit Dental-Ansatz.

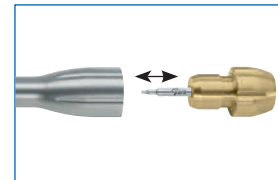

Note:

All products marked with **QB** can be used with **quattro** and **BENEFIT** screws!

Hinweis:

Alle mit **QB** gekennzeichneten Instrumente eignen sich zum Einsetzen von **quattro** und **BENEFIT** Schrauben!



33-54519

not autoclavable! | nicht autoklavierbar!

BENEFIT Activating Screwdriver
BENEFIT Aktivierungsschraubendreher

acc./nach Dr. Michael Schubert, Regensburg, Germany



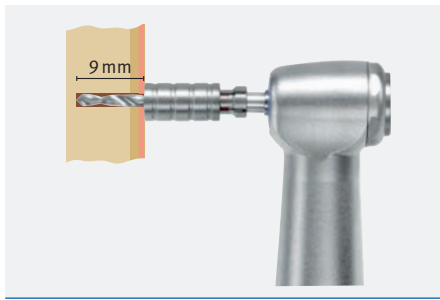

The drill stop prevents the clinician from unintentionally drilling too deep. They assure an accurate working length from 7 to 13 mm in 2 mm increments. By sliding the stop sleeve over the appropriate PSM drill, the working length is adjusted to the desired depth. Removal of the sleeve is easy using the buffer.

Die Bohrerstophülsen verhindern ein zu tiefes Vorbohren durch eine vorher definierte Arbeitslänge von 7 bis 13 mm (2 mm Schritte). Die gewünschte Bohrtiefe wird durch einfaches Aufstecken der entsprechenden Stophülse auf die dafür geeigneten PSM Bohrer erreicht. Das leichte Entfernen erfolgt mit Hilfe des Entkopplers.

DRILL STOP
BOHRERSTOP

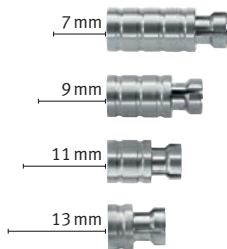

33-18307

33-18309

33-18311

33-18313

Stop sleeve
Stophülsen

33-18300

Set, includes 4 sleeves (7 to 13 mm) without buffer

Set, enthält 4 Hülsen (7 bis 13 mm) ohne Entkoppler

33-18301

ditto but with buffer
ditto aber mit Entkoppler



33-18302

Buffer
Entkoppler



Video



73-31888

Tray for Drill Stop Set, empty
Behälter für Bohrerstop Set, leer



12-12625 QB DENTAL

Drill, 1.0x33 mm, WL 15 mm, green, for 1.5 mm screws

Bohrer, 1,0x33 mm, AT 15 mm, grün, für 1,5 mm Schrauben



10-67513 QB DENTAL

Drill, 1.4x33 mm WL 15 mm, red, for 2.0 mm screws

Bohrer, 1,4x33 mm AT 15 mm, rot, für 2,0 mm Schrauben



11-18452 QB DENTAL

Drill, 1.8x33 mm WL 15 mm, grey, for 2.3 mm screws

Bohrer, 1,8x33 mm AT 15 mm, grau, für 2,3 mm Schrauben



ST-33-10170 * ST

MOPS Bone-Rapper, 70 mm, 9 mm thread, diameter 2.0 mm

MOPS Bone-Rapper, 70 mm, 9 mm Gewinde, 2,0 m Durchm.

used with 10-61000
verwendbar mit 10-61000



ST-33-10177 * ST

MOPS Bone-Rapper, 70 mm, 11 mm thread, diameter 2.0 mm

MOPS Bone-Rapper, 70 mm, 11 mm Gewinde, 2,0 m Durchm.



ST-33-10133 ST

MOPS Bone-Rapper, 33 mm, for contra angled handpiece

MOPS Bone-Rapper, 33 mm, für Winkelhandstück



10-61000

Screwdriver handle, only
Schraubendreher Handgriff, allein

All drills:
max. 800 rpm
or manually
Alle Bohrer:
max. 800 U/min
oder manuell
WL = Working length
AT = Arbeitsteillänge

MIKRO-OSTEO-PERFORATION
MICRO OSTEO-PERFORATION

Packaging: 1ea.
VPE: 1Stk.

Material: Titanium
Material: Titan

ST

Note:

MOPS Bone-Rappers are supplied in sterile single use packaging.

Hinweis:

Alle **MOPS Bone-Rapper** werden grundsätzlich in einer sterilen Einzelpackung geliefert.

*as long as stock lasts / solange der Vorrat reicht

DE FRANCO
DE FRANCO

Packaging: 1ea.
VPE: 1Stk.

Recommended drill:
Empfohlener Bohrer:



33-10814 ● DENTAL

EasyDriver Drill, 1.4mm, red
EasyDriver Vorbohrer,
1.4mm, rot

Developed with:
Entwickelt mit:
Dr. David J. De Franco
Milano, Italy



DE FRANCO Parallel-Guides **NEW**

Drill-Guides / Bohrführung



33-54576

Distance 6mm + 8mm
Abstand 6mm + 8mm



33-54577

Distance 7mm + 10mm
Abstand 7mm + 10mm



33-54570

Universal Parallel Drill-Guide
Universal Parallel Bohrhilfe

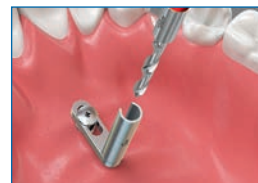

Screw-Guides / Schraubführung



33-54578

Distance 6mm + 8mm
Abstand 6mm + 8mm



33-54579

Distance 7mm + 10mm
Abstand 7mm + 10mm



33-54571

Universal Parallel Screw-Guide
Universal Parallel Schraubhilfe



BENEFit
MAXILLARY XPANDER
BENEFit
MAXILLARY XPANDER

bmX **BENEFit**
Maxillary
Xpander **NEW**

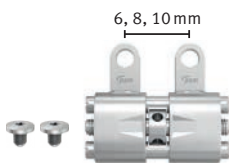

Max. Expansion: 10mm
Max. Ausdehnung: 10mm

33-57506 6mm

33-57508 8mm

33-57510 10mm

bmX, palatal expander incl. 2 fixation screws
bmX, Gaumennahtspreizer inkl. 2 Fixierschrauben



bmX, De Franco
Video



News 25/26

After using the **BENEFit** Screw for the Hybrid Hyrax appliance very successfully in the last years the **bmX** now follows the Orthodontists request for an entirely **BENEFit** mini-implant anchored appliance for Rapid maxillary expansion on young patients. Using the De Franco Screwguide the distance and the parallelity of the **BENEFit** Screws can exactly be determined, directly on the patient. An impression is no longer necessary. Alternatively visualisation can of course be made by means of digital imaging or traditional impression taking.

Nach dem erfolgreichen Einsatz der **BENEFit** Schraube bei der Hybrid-Hyrax wird mit dem **bmX** dem Wunsch vieler Kieferorthopäden nach einer allein durch **BENEFit** Schrauben verankerten Apparatur zur Gaumennahterweiterung bei jungen Patienten entsprochen. Mit Hilfe der DeFranco Schraubführung kann der Abstand und die Parallelität der **BENEFit** Schrauben direkt am Patienten dargestellt werden. Eine Abformung entfällt. Alternativ kann natürlich auch eine digitale Bildarstellung oder eine herkömmliche Abformung zum Einsatz kommen.



33-54532

BENEsliDer tubes, 2 ea.
BENEsliDer Röhrchen, 2 Stk.



33-54537

Lingual sheath, 2 ea.
Palatinalschloss, 2 Stk.



33-54523

NEW

BENEsliDer hook, 10 ea.
BENEsliDer Haken, 10 Stk.



Example

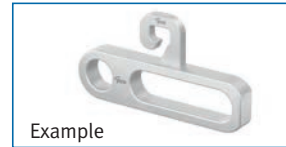

Example



33-54534

NEW

Tubes, 10 ea.
Röhrchen, 10 Stk.



Example



6, 10, 12 mm

33-54495 140 gr. 6 mm, soft / leicht

33-54496 200 gr. 6 mm, medium / mittel

33-54497 250 gr. 6 mm, strong / stark

33-54695 140 gr. 10 mm, soft / leicht

33-54696 200 gr. 10 mm, medium / mittel

33-54697 250 gr. 10 mm, strong / stark

33-54795 140 gr. 12 mm, soft / leicht

33-54796 200 gr. 12 mm, medium / mittel

33-54797 250 gr. 12 mm, strong / stark



33-54524 240 gr.

33-54525 500 gr.

BENEsliDer NiTi springs, 2 ea.
BENEsliDer NiTi Federn, 2 Stk.

MesialsliDer NiTi coil springs, 2 ea.

MesialsliDer NiTi Zugfedern, 2 Stk.



33-10760

Scanbody PEEK Standard
Scanbody PEEK Standard



33-10761

Scanbody PEEK mini
Scanbody PEEK mini



ACCESSORIES

HILFSMITTEL

Material: Steel
Material: Stahl

SPRINGS

FEDERN

Material: NiTi
Packaging: 2 ea.
VPE: 2 Stk.

SCANBODIES

SCANBODIES

Material: PEEK
Packaging: 1ea.
VPE: 1Stk.

BENEFIT® screws will be i.e. available for virtual case planning within the following software libraries:

BENEFIT®-Schrauben werden u.a. in den virtuellen Fallplanungen folgender Software Bibliotheken verfügbar:

- 3 shape
- Onyxceph TAD match
- EASY DRIVER
- more to come (pls ask your service partner)

As a further step into Digitalization of the **BENEFIT®**-System these scanbodies were developed in cooperation with orthodontist Simon Graf (Belp, Switzerland) to ensure visualization of a detailed rendering.

The Scanbody Standard is used right after implant insertion. The Scanbody mini can be screwed onto the implants even after several months of treatment.

Als weiteren Schritt in die Digitalisierung des **BENEFIT®**-Systems hat PSM in Zusammenarbeit mit dem Kieferorthopädem Simon Graf (Belp, Schweiz) diese Scanbodies entwickelt, die eine detailgetreue digitale Wiedergabe ermöglichen.

Das Scanbody Standard findet unmittelbar nach der Implantatinsertion Anwendung. Das Scanbody mini kann aufgeschraubt auch noch nach einigen Monaten Behandlungszeit eingesetzt werden.

MOBILHOLDER
MOBILHOLDER

for Beneslider,
Mesialslider



Abb. / fig. 3

The new Mobilholder is intended to move the **BENEFIT®** Mobilizers into the final position prior to tightening the set screw for Distalization (fig. 1/2) or Mesialization (fig. 3).

Der neue Mobilholder kann verwendet werden um die **BENEFIT®** Mobilisatoren für die Distalisierung (Abb. 1/2) oder Mesialisierung (Abb. 3) in die gewünschte Position zu bewegen.



Abb. / fig. 1



Abb. / fig. 2



33-18290

Mobilholder acc. to. ZTM W. Bervoets
Mobilholder nach ZTM W. Bervoets

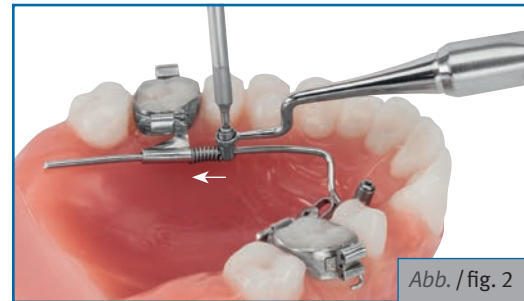
Can be used with:
Kann verwendet werden mit:



33-54540

Mobilizer for wires from
0.5 to 1.2 mm
Mobilisator für
0,5 – 1,2 mm Draht



33-54541

Mobilizer
with hook
Mobilisator
mit Haken



33-54543

Micro Mobilizer for wires
from 0.5 to 1.2 mm
Mikro Mobilisator für
0,5 – 1,2 mm Draht



33-54553

Micro Mobilizer
with hook
Mikro Mobilisator
mit Haken

SCREW LOCATION PROBE
ZIELSONDE

median

The soft tissue probes are infinitely adjustable and are fixed by means of the normal **BENEFIT®** instruments (i. e. 33-54512) with set screws in the desired position.

paramedian

Die Markiersonden sind je nach geforderter Distanz stufenlos verstellbar und über Stellschrauben mit dem vorhandenen **BENEFIT®** Instrumentarium (z. B. 33-54512) arretierbar.

The screw location probe acc. to Dr. Schlichter identifies the target points for the median or paramedian placement of the **BENEFIT®** Screws. The precise positioning of the **BENEFIT®** Implants improves the location and parallelism with each other. It also increases stability and simplifies the chairside bending of the plate. Additionally the lab time is reduced due to less bending.

Die Zielsonde nach Dr. Schlichter markiert die zur Anbringung einer **BENEplate** median oder paramedian vorgesehenen Zielpunkte. Die durch die definierte Einbringung verbesserte Lage der **BENEFIT®**-Implantate zueinander und die damit parallel ausgerichteten Implantatschulter verbessern die Lagestabilität der Schrauben und erleichtern eine Anpassung der Beneplate chairside. Des Weiteren ist beim Anpassen der Beneplate durch den Zahntechniker mit weniger Zeitaufwand und einer geringeren Verformung der Beneplate zu rechnen.



Developed in cooperation with Dr. Kai Schlichter, Dres. Werling & colleagues, Offenbach a. d. Q., Germany
Entwickelt in Zusammenarbeit mit Dr. Kai Schlichter, Dres. Werling & Kollegen, Offenbach a. d. Q., Deutschland



33-18451

Soft Tissue Probe holder, 1 ea.
Sondenhalter Schlichter, 1 Pkg.



33-18452

Soft Tissue Probe, 2 ea.
Mucosa Markiersonde, 2 Pkg.

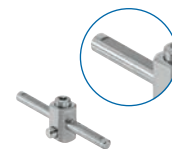

33-18453

Connecting rod for soft tissue probe, 1 ea.
Querbügel für Markierungs-sonde, 1 Stk.



33-18450

BENEFIT® Screw Location Probe Set complete, 4 parts
BENEFIT® Markiersonde Set komplett, 4-teilig



33-54520

(see page 16)

Multi purpose handle for the use with all instruments with dental shaft end.
Vielzweck-Handgriff für die Aufnahme aller Instrumente mit Dental-Ansatz.



BENESLIDER TITANIUM
BENESLIDER TITANIUM

Material: Titanium
Material: Titan
Packaging: Set only
VPE: nur als Set



The parts of the new PSM **BENESlider Titanium** are manufactured from surgical titanium according to American and European Standards providing biocompatible material for nickel or steel allergic patients. The specially gold anodized titanium surface identifies the titanium parts and offers an increased titanium-oxid layer for perfect biocompatibility.

Alle Teile des neuen PSM **BENESliders Titanium** werden aus chirurgischem Titan gemäß amerikanischen und europäischen Normen hergestellt und eignen sich vor allem für nickel- oder stahlallergische Patienten. Die spezielle gold-anodisierte Titanoberfläche kennzeichnet die Titanartikel und bietet eine erhöhte Titanoxidschicht mit optimaler Biokompatibilität.

BENESlider Titanium Set REF: 33-54605**

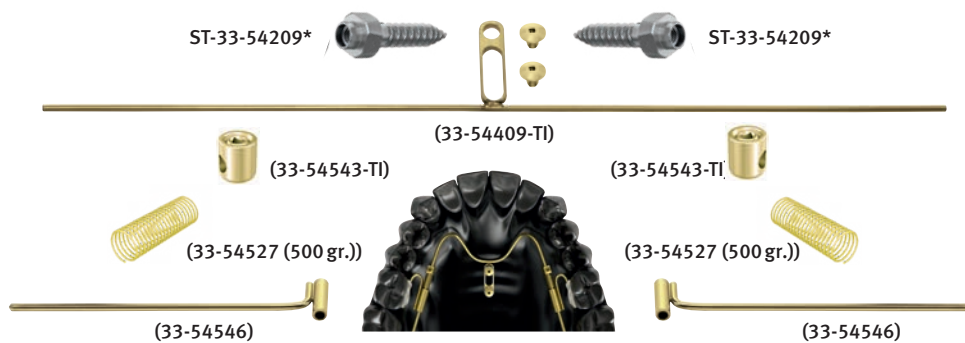

33-54605

BENESlider Titanium Set complete incl. 2x **Benefit®** Screws 2.0x 9 mm*
BENESlider Titan Komplettsset inkl. 2x **Benefit®** Schrauben 2.0x9 mm*

*For different screws sizes please notice this in your order.

*Bitte vermerken Sie bei Ihrer Bestellung die gewünschte Schraubengröße.

The **BENESlider titanium set is only available as a complete set. Parts are not sold separately.

Das **BENESlider Titanium Set ist nur als Komplettsset erhältlich. Teile sind nicht einzeln erhältlich.



Cordless Battery Screwdriver with Torque Calibration System for the fixation of **quattro** and **BENEFIT** Miniscrews.

The iSD 900 will guarantee precise torque control due to the unique – easy to use – torque calibration system (10–40 Ncm). Time-saving and precise, risk-free insertion and tightening of screws and abutments.

The complete Set contains a reliable and user friendly handpiece for Dental attachments. Reverse mode is indicated with sound. Standard rechargeable AAA Ni-Mh batteries can be used.

Kabelloser Akku Schraubendreher mit Drehmoment-Kalibrierung zum kontrollierten Eindrehen von **quattro** und **BENEFIT** Minischrauben.

Der iSD900 garantiert, Dank seines einzigartigen, höchst einfach zu bedienenden Drehmoment-Kalibriersystems eine stufenlose Drehmomentkontrolle (10–40 Ncm). Der iSD900 trägt entscheidend zur Zeiteinsparung bei und ermöglicht ein präzises und risikofreies Arbeiten.

Das Komplett-Set enthält ein zuverlässiges und langlebiges Winkelstück mit leichtem Zugang. Der Rückwärtslauf wird durch ein akustisches Signal angezeigt. Der Standardakku (AAA Ni-MH) kann einfach ausgetauscht werden.

iSD900

BATTERY SCREWDRIVER
AKKU SCHRAUBENDREHER

FEATURES VORTEILE

- 10–40 Ncm torque in 1 or 5 increments
- 5, 10, 15, 25 rpm turning speed
- Reverse mode with sound
- Calibration facility
- Standard rechargeable batteries



33-900-00 iSD900 consisting of / bestehend aus:

33-900-04	Motor	Handgriff mit Motor
33-900-08	Handpiece DENTAL	Winkelansatz DENTAL
33-900-10	Quick Charger Unit	Schnellladestation
33-900-12	Power Cord	Netzkabel
33-900-14	Torque Calibrator	Drehmoment Kalibrierer
33-900-16	Calibration Burr	Kalibrierstift
33-900-18	On/Off Switch Lever	Ein/Aus Komfort-Bügel
33-900-20	Ni-Mh Rechargeable Battery (Pack of 2)	Ni-Mh Akkus (2 Stk.)



Torque Calibrator
Drehmoment Kalibrierer

**BALL ABUTMENT
KUGELABUTMENT**

Material: Titanium
Material: Titan

NEW



33-54467

BENEFIT Ball Abutment,
acc. Dr. S. Renger, 2 ea.

BENEFIT Kugelabutment,
nach Dr. S. Renger, 2 Stk.



33-54804

Rigid Matrix, closed,
green 4N, 8 ea.

Starre Matrize,
geschl., grün 4N, 8 Stk.



33-54806

Rigid Matrix, closed,
yellow 6N, 8 ea.

Starre Matrize,
geschl., gelb 6N, 8 Stk.



33-54808

Rigid Matrix, closed,
red 8N, 8 ea.

Starre Matrize,
geschl., rot 8N, 8 Stk.



33-54810

Matrix Housing for bonding or laser welding,
Titanium 2 ea.

Matrizengehäuse zum Kleben oder
Laserschweißen, Titan 2 Stk.



33-54811

Matrix Housing for acrylic work, Titanium 2 ea.

Matrizengehäuse für Kunststoffbearbeitung,
Titan 2 Stk.



33-54824

Semi Matrix, green 4N,
8 ea.

Halbe Matrize, grün
4N, 8 Stk.



33-54826

Semi Matrix, yellow
6N, 8 ea.

Halbe Matrize, gelb 6N,
8 Stk.



33-54828

Semi Matrix, red 8N,
8 ea.

Halbe Matrize, rot 8N,
8 Stk.



With the new ball abutment PSM offers a new possibility for temporary prosthetic treatment as well as skeletal anchorage of removable orthodontic appliances. For further accessories and informations please refer to our separate catalogue and instructions for use.

Mit dem neuen Kugelabutment bietet PSM eine neue Möglichkeit für die temporäre prothetische Versorgung sowie die skeletale Verankerung von nicht-festsitzenden kieferorthopädischen Apparaturen. Weiteres Zubehör und Informationen finden Sie in unserem separaten Prospekt und der Gebrauchsanweisung.

TRAYS
BEHÄLTER



73-31960

QB

quattro®/BENEFIT® Sterilization and storage tray for instruments and implants, empty
quattro®/BENEFIT® Sterilisier- und Aufbewahrungsbehälter für Implantate und Instrumente, leer



73-31990

BENEFIT® Starter Sterilization tray, empty
BENEFIT® Starter Sterilisierbehälter, leer



73-90000

Utility storage box, not for sterilization, with forceps, empty
Kleinteile-Aufbewahrungsbox, nicht zum Sterilisieren, mit Pinzette, leer

■ **Note:**
All products marked with **QB** can be used with **quattro®** and **BENEFIT®** screws!

■ **Hinweis:**
Alle mit **QB** gekennzeichneten Instrumente eignen sich zum Einsetzen von **quattro®** und **BENEFIT®** Schrauben!

BENEFIT® STARTER INSTRUMENT SET S
BENEFIT® STARTER INSTRUMENTEN SET S

STARTER KIT

S



33-55000

BENEFIT® Starter Instrument Set without implants consisting of:

S

BENEFIT® Starter Instrumenten Set ohne Implantate bestehend aus:

S

Storage/Sterilization

Aufbewahrung/Sterilisation

73-31990

BENEFIT® Starter tray, empty

BENEFIT® Starter Behälter, leer

Instruments

Instrumente

33-18236

Thumb screw for Dental mandrel

Handgriff für Klingen mit Dentalansatz

33-54512

Screwholder for Abutment screw, 20 mm

Eindrehinstr. für Abutment Schraube, 20 mm

33-18232

Screwholder for implants, 23 mm

Schraubenhalter für Implantate, 23 mm

10-67513

Drill, 1,4x33 mm WL 15 mm, DENTAL, red

Bohrer, 1,4x33 mm AT 15 mm, DENTAL, rot

BENEFIT® STARTER INSTRUMENT SET M
BENEFIT® STARTER INSTRUMENTEN SET M

STARTER KIT

M



33-55001

BENEFIT® Starter Instrument Set without implants consisting of:

M

BENEFIT® Starter Instrumenten Set ohne Implantate bestehend aus:

M

Storage/ Sterilization

Aufbewahrung/Sterilisation

73-31990

BENEFIT® Starter tray, empty

BENEFIT® Starter Behälter, leer

Instruments

Instrumente

33-18236

Thumb screw for Dental mandrel

Handgriff für Klingen mit Dentalansatz

33-54512

Screwholder for Abutment screw, 20 mm

Eindrehinstr. für Abutment Schraube, 20 mm

33-18232

Screwholder for implants, 23 mm

Schraubenhalter für Implantate, 23 mm

10-67513

Drill, 1,4x33 mm WL 15 mm, DENTAL, red

Bohrer, 1,4x33 mm AT 15 mm, DENTAL, rot

+

33-18244

Extension + 16mm

Verlängerung + 16mm

STARTER KIT

L



BENEFIT® STARTER INSTRUMENT SET L
BENEFIT® STARTER INSTRUMENTEN SET L

33-55002

BENEFIT® Starter Instrument Set without implants consisting of:

Storage/Sterilization

73-31990

BENEFIT® Starter tray, empty

Instruments

33-18236
33-54512
33-18232
10-67513

Thumb screw for Dental mandrel
Screwholder for Abutment screw, 20mm
Screwholder for handpiece, 23mm
Drill, 1,4x33 mm WL 15 mm, DENTAL, red

BENEFIT® Starter Instrumenten Set ohne Implantate bestehend aus:

Aufbewahrung/Sterilisation

BENEFIT® Starter Behälter, leer

Instrumente

Handgriff für Klingen mit Dentalansatz
Eindrehinstr. für Abutment Schraube, 20mm
Schraubenhalter für Winkelhandstück, 23mm
Bohrer, 1,4x33 mm AT 15 mm, DENTAL, rot

+

33-18237
33-54515

Screwholder for implants, 33mm
Screwholder for Abutment screw, 30mm

Schraubenhalter für Implantate, 33mm
Eindrehinstr. für Abutment Schraube, 30mm

STARTER KIT

XL



BENEFIT® STARTER INSTRUMENT SET XL
BENEFIT® STARTER INSTRUMENTEN SET XL

33-55005

BENEFIT® Starter Instrument Set without implants consisting of:

Storage/Sterilization

73-31990

BENEFIT® Starter tray, empty

Instruments

33-18236
33-54512
33-18232
10-67513

Thumb screw for Dental mandrel
Screwholder for Abutment screw, 20 mm
Screwholder for handpiece, 23 mm
Drill, 1,4x33 mm WL 15 mm, DENTAL, red

BENEFIT® Starter Instrumenten Set ohne Implantate bestehend aus:

Aufbewahrung/Sterilisation

BENEFIT® Starter Behälter, leer

Instrumente

Handgriff für Klingen mit Dentalansatz
Eindrehinstr. für Abutment Schraube, 20 mm
Schraubenhalter für Winkelhandstück, 23 mm
Bohrer, 1,4x33 mm AT 15 mm, DENTAL, rot

+

33-18244
33-18288

Extension + 16mm
Laboratory finger screwdriver, fixed

Verlängerung + 16mm
Labor Finger Schraubendreher, fixiert

BENEFIT®
INSTRUMENT SET
BENEFIT®
INSTRUMENTEN SET

Recommendation
Empfehlung

■ **Note:**

*Set illustration can deviate from our set recommendation.

■ **Hinweis:**

*Setabbildung kann vom Satzvorschlag abweichen.



33-54100	quattro® / BENEFIT® Instrument Set consisting of:	quattro® / BENEFIT® Instrumenten Set bestehend aus:
	Storage	Aufbewahrung
73-31960 73-90000	quattro® / BENEFIT® sterilization tray, empty Utility storage box	quattro® / BENEFIT® Sterilisierbehälter, leer Kleinteile-Aufbewahrungsbox
	Instruments	Instrumente
10-61000 33-18230 33-18236 33-54512 33-18232 10-67513	Screwdriver handle, only Screwholder, long, for 10-61000 Thumb screw for Dental mandrel Screwholder for Abutment screw, 20 mm Screwholder for contra-angled handpiece, 23 mm Drill 1.4x33 mm WL 15 mm, DENTAL, red	Schraubendreher Handgriff, allein Schraubenhalter, lang, für 10-61000 Handgriff für Instrumente mit Dentalansatz Eindrehinstr. für Abutment Schraube, 20 mm Schraubenhalter für Winkelhandstück, 23 mm Bohrer 1,4x33 mm AT 15 mm, DENTAL, rot



10-61000
Screwdriver handle, only
Schraubendreher Handgriff, allein



33-18230 66 mm
Screwholder, long, for **10-61000**
Schraubenhalter, lang, für **10-61000**



33-18236
Thumb screw for Dental shaft instruments
Handgriff für Instrumente mit Dentalansatz



33-54512
Screwdriver insert
Eindrehinstrument



33-18232 23 mm **DENTAL**
Screwholder for contra-angled handpiece
Schraubenhalter für Winkelhandstück



10-67513 **DENTAL**
Drill, 1.4x33 mm WL 15 mm, red, for 2.0 mm screws
Bohrer, 1,4x33 mm AT 15 mm, rot, für 2,0 mm Schrauben



73-90000
Utility storage box, not for sterilization, with forceps, empty
Kleinteil-Aufbewahrungsbox, nicht zum Sterilisieren, mit Pinzette, leer

Illustration s.a.
Abbildung s.o.

73-31960
Sterilization and storage tray
Sterilisier- und Aufbewahrungsbehälter

Beneslider distal/distal

33-54595	BENEs slider Set 240 gr. with long BENEtubes	BENEs slider Komplettsset 240 gr. mit langen BENEtubes
33-54409	BENEs plate short with 1.1mm s/s wire <i>incl. 2 fixation screws</i>	BENEs plate kurz mit 1.1mm Stahldraht inkl. 2 Fixierschrauben
33-54540	Mobilizer for wires from 0,5-1,2mm, 2 ea.	Mobilisator für Draht von 0,5-1,2mm, 2 Stk.
33-54524	BENEs slider NiTi Springs, 240gr, 2 ea.	BENEs slider NiTi Federn, 240g, 2 Stk.
33-54536	BENEs tube long, 2 ea.	BENEs tube lang, 2 Stk.

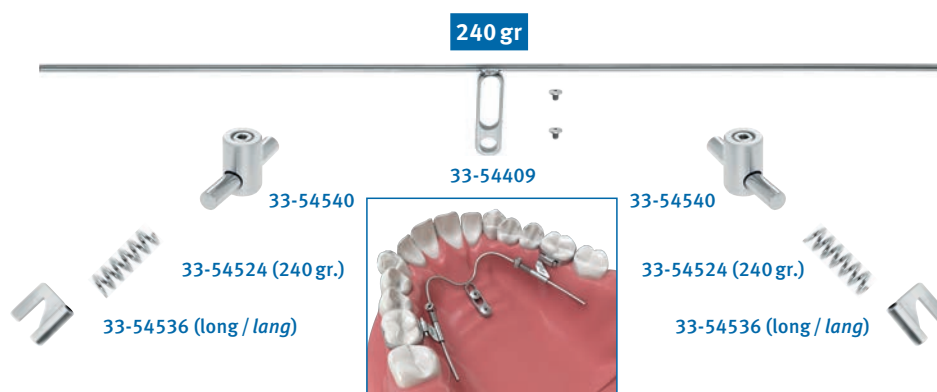

33-54596	BENEs slider Set 500 gr. with long BENEtubes	BENEs slider Komplettsset 500 gr. mit langen BENEtubes
33-54409	BENEs plate short with 1.1mm s/s wire <i>incl. 2 fixation screws</i>	BENEs plate kurz mit 1.1mm Stahldraht inkl. 2 Fixierschrauben
33-54540	Mobilizer for wires from 0,5-1,2mm, 2 ea.	Mobilisator für Draht von 0,5-1,2mm, 2 Stk.
33-54525	BENEs slider NiTi Springs, 500gr, 2 ea.	BENEs slider NiTi Federn, 500g, 2 Stk.
33-54536	BENEs tube long, 2 ea.	BENEs tube lang, 2 Stk.

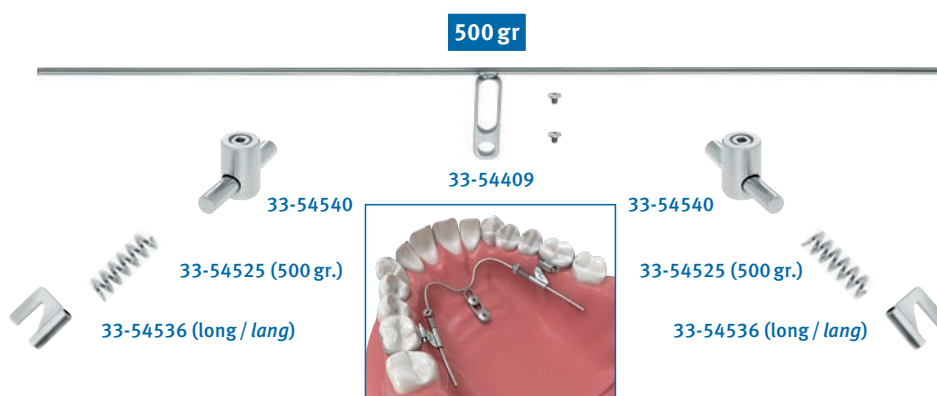

BENEs slider SET
DISTAL/DISTAL
BENEs slider
DISTAL/DISTAL SET

Recommendation
Empfehlung



BENEs slider Video

BENEslieder SET
BENEslieder SET

Recommendation
Empfehlung



BENEslieder
Mesialization Video

Beneslider mesial/mesial

33-54612	BENEslieder Set mesial/mesial	BENEslieder mesial/mesial Set
33-54409	BENEplate short with 1.1mm s/s wire incl. 2 fixation screws	BENEplate kurz mit 1.1mm Stahldraht inkl. 2 Fixierschrauben
33-54553	Micro Mobilizer with hook, 2 ea.	Micro Mobilisator mit Haken, 2 Stk.
33-54496	Coil springs 200gr medium, 6mm, 2 ea.	Zugfedern 200g mittel, 6mm, 2 Stk.
33-54539	Mesialtube with hook, 2 ea.	Mesialtube mit Haken, 2 Stk.



Beneslider mesial/distal

33-54613	BENEslieder Set mesial/distal	BENEslieder mesial/distalSet
33-54409	BENEplate short with 1.1mm s/s wire incl. 2 fixation screws	BENEplate kurz mit 1.1mm Stahldraht inkl. 2 Fixierschrauben
33-54553	Micro Mobilizer with hook, 2 ea.	Micro Mobilisator mit Haken, 2 Stk.
33-54496	Coil springs 200gr medium, 6mm, 2 ea.	Zugfedern 200g mittel, 6mm, 2 Stk.
33-54539	Mesialtube with hook, 2 ea.	Mesialtube mit Haken, 2 Stk.
33-54543	Micro Mobilizer for wires from 0.5 to 1.2 mm	Micro Mobilisator für 0,5 – 1,2 mm Draht
33-54525	BENEslieder NiTi springs, 500gr, 2 ea.	BENEslieder NiTi Federn, 500g, 2 Stk.
33-54536	BENEtube, long, 2 ea.	BENEtube, lang, 2 Stk.



Due to the large possibility of Set variations available with the BENEFIT System we only have shown the most common variations in this catalogue. Your local PSM distribution partner will be pleased to give you further assistance.

Aufgrund der Vielzahl der möglichen Set-Variationen die mit dem BENEFIT System möglich sind, haben wir auf dieser Seite nur die gängigsten Varianten aufgeführt. Unsere Fachhändler beraten Sie gerne zu weiteren Möglichkeiten.

benefit

For more information please refer to our **BENEFIT**® Manual or our website www.psm.ms

Für mehr Informationen verweisen wir auf unseren **BENEFIT**® Handout oder auf unsere Webseite www.psm.ms



CATALOGS KATALOGE

Even more innovative PSM products are presented in our other catalogues. Please request it from your local PSM distribution partner or download from our website www.psm.ms.

Noch mehr innovative PSM Produkte finden Sie in unseren anderen Katalogen. Gleich anfordern oder einfach downloaden unter www.psm.ms.

quattro

The **quattro**® Mini Anchor System is known as one of the first and most successful orthodontic Mini-Implant Systems worldwide. Based on this system the **BENEFIT**® screws were developed. This enables the user to utilize the entire scope of orthodontic implantation with unmatched possibilities and compatible instrumentation.

Das **quattro**® Mini Anker System gilt als eines der ersten und erfolgreichsten kieferorthopädischen Mini-Implantatsysteme weltweit. Basierend auf diesem System wurden die **BENEFIT**® Schrauben entwickelt. Das ermöglicht es dem Anwender mit denselben Instrumenten die komplette Bandbreite der kieferorthopädischen Implantation und damit bisher unerreichte Möglichkeiten auszuschöpfen.



quattro standard



quattro hook



quattro plus



quattro plus V



quattro mini



mentoplate

The Mentoplate-System provides a perfect solution for enhanced stability with special orthodontic bone anchored plates for intraoral fixation in the maxilla and the mandible. The System includes Titanium plates which are fixed to the bony surface with selfdrilling screws.

Das Mentoplate-System bietet mit speziellen kieferorthopädischen Knochenplatten für die intraorale Fixierung im Unter- und Oberkiefer die perfekte Lösung, um eine erhöhte Verankerungsstabilität zu erreichen. Das System beinhaltet Titanplatten, die mit selbstbohrenden Schrauben auf dem Knochen fixiert werden.



BENEFIT®, **quattro**®, **mentoplate**®, **BENEslder**®, **BENEsplate**®, **bmx**® are registered trademarks of PSM Medical Solutions, Germany.

BENEFIT®, **quattro**®, **mentoplate**®, **BENEslder**®, **BENEsplate**®, **bmx**® sind eingetragene Marken von PSM Medical Solutions, Germany.

BENEFIT® .KFO

Distribution | Vertrieb:

Distribution in USA:

psm North America

PMB 142
49950 Jefferson Street
Suite 130, Indio, CA 92201

Toll-free: 800-733-1622

service@psm-na.us
www.psm-na.us

Manufacturer | Hersteller:

psm MEDICAL SOLUTIONS

Moltkestraße 41
78532 Tuttlingen, Germany

Phone +49 (74 61) 9 66 37-0
Fax +49 (74 61) 9 66 37-29

E-Mail info@psm.ms
Web www.psm.ms

© 2018 **psm** MEDICAL SOLUTIONS | Germany

Specifications and design are subject to change without prior notice. All pictures, photos and product descriptions are the property of **psm** MEDICAL SOLUTIONS. Utilization and copies by third parties have to be authorized by **psm** MEDICAL SOLUTIONS. All rights reserved!

All trademarks and brands mentioned in this brochure are subject to unrestricted regulations of the trade mark laws valid and right of ownership of the registered owner.

Von dem Produkt-Katalog abweichende Katalog- und Konstruktionsänderungen, die der Modifikation und Weiterentwicklung dienen behalten wir uns vor. Abbildungen, Produktbeschreibungen und Texte sind Eigentum der Firma **psm** MEDICAL SOLUTIONS. Weiterverwendung und Vervielfältigung durch Dritte bedürfen der ausdrücklichen Genehmigung der Firma **psm** MEDICAL SOLUTIONS. Alle Rechte vorbehalten!

Alle in dieser Broschüre genannten und ggf. durch Dritte geschützten Marken- und Warenzeichen unterliegen uneingeschränkt den Bestimmungen des jeweils gültigen Kennzeichenrechts und den Besitzrechten der jeweiligen eingetragenen Eigentümer.